



Our Georgian bars are a snap to use!

Snap-on Georgian Bars

- External and Internal Georgian bars - that snap in place, giving a more authentic look than 'in-unit' alternatives
- Reduce production time
- Fast, efficient installation on site if required
- An easy up-sell to consumers, and a good way to get ahead in the new build market
- Available in woodgrain finishes as well as white



Units can have bars applied to either one or both sides of the window as required and the bars will flex with the unit – so that if “toe and heeling” is required this will not impact on the effectiveness of the bars. If, however, reglazing is required, then the bars can be easily removed and reapplied on site.

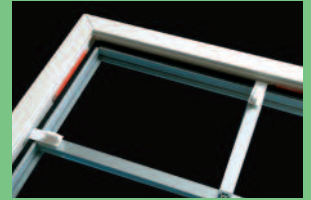

- The components comprise edge clips, centre clips and the Georgian Bars.
- The Geo Fast clips have a world-wide patent.
- Place the edge clips in the required positions around the sealed glazing units.
- Glaze window as per manufacturing any glazing instructions. Ensure that clips have retained their position prior to final beading.
- Using an alcohol wipe ensure that all surfaces are clean, dry and free of grease.
- Accurately align the centre clip to the edge clips, place a 40mm length of double sided tape to the underside of the centre clip and fix in place.
- Precisely cut and mitre the full length bar. This should always be the shortest span for maximum rigidity.
- Cut and mitre the remaining bars and complete installation.

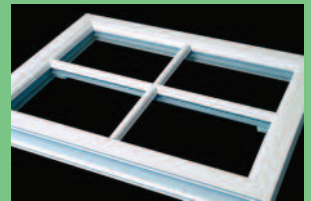
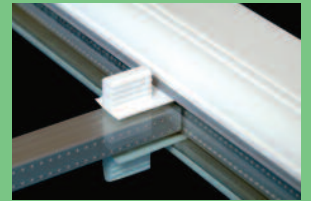

Traditional Bar Components



GB1 CHAMFERED BAR



GB2 FEATURED BAR

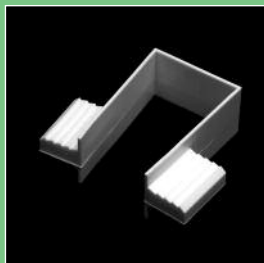

GC 24/28 BAR CLIP

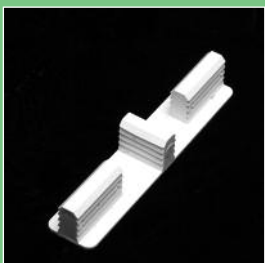

GCC CRUCIFORM CLIP

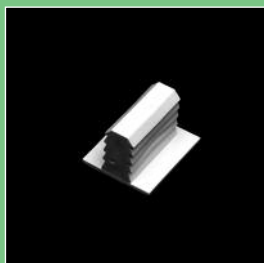

BRIDGING INTERMEDIATE PIECE

Georgian Bar snap-on system

Geo=Fast

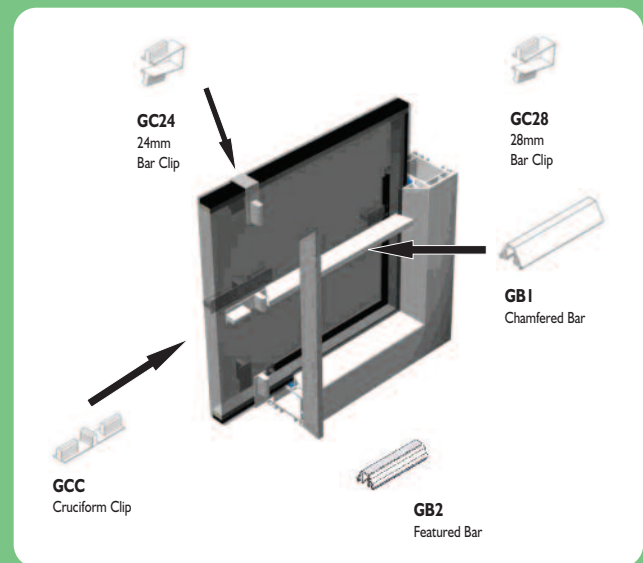

The Georgian Bar Company Limited

Unit 1, Clifton Business Park,
Preston New Road, West Preston. PR4 0XQ

Tel: 01772 631441 | Fax: 01772 679886

Email: sales@geofast.co.uk | www.geofast.co.uk